



For Earth, For Life
Kubota

KX

**KUBOTA COMPACT EXCAVATOR
KX033-4**

Designed for efficiency, built for stability, and created for comfort,
the new KX033-4 redefines the compact excavator.



*This information is sourced from overseas and may not necessarily apply locally. It is essential that you confirm specifications and other information with your local Kubota dealer.



**A roomy and comfortable cabin.
Impressive stability and incredible power.
The KX033-4 is a compact excavator with
class-busting performance.**

WORKABILITY

Extraordinary Stability and Lifting Capacity

With the stability and lifting capacity of a much bigger machine, the 3-ton class KX033-4 offers a level of performance to efficiently handle a wide variety of tough excavating jobs. An innovative counter balance ensures superior excavator stability, while the low center of gravity and double-flanged lower track rollers deliver safe and efficient operation when working to the side with hydraulic attachments or lifting heavy objects.

Strong Bucket Breakout Force

When heavily loaded, the KX033-4's outstanding bucket breakout force lets you handle even the toughest excavating jobs with speed and efficiency.

Wide Working Range

The KX033-4's powerful and responsive front working group gives you the confidence to handle a wide range of digging, lifting, and loading jobs.

Aux1 Diverter Valve

The diverter valve allows auxiliary oil to be diverted to the operation of auxiliary attachments without removal of the thumb attachment pipeline for increased efficiency on the go.

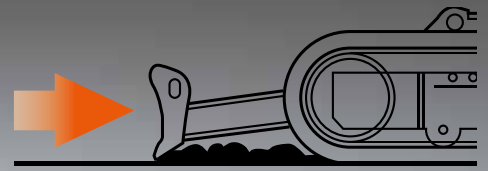

Float Position

The float function is a standard feature on the KX033-4. Ground finishing work can be completed quickly and simply without the need to adjust the dozer height. After backfilling, simply travel backwards along the covered ditch with the dozer in the float position.

Generous Approach Angle

Navigate ramps and over obstacles with confidence—Kubota's blade has a 32 degree approach angle.





DELUXE INTERIOR

With a larger entrance, more legroom, a spacious interior designed for comfort, and enhanced ergonomics that simplify routine operations, the KX033-4's luxurious cabin redefines operator efficiency.

Easy-open Front Slide Window

Unlike many excavator windows, the front glass window of the KX033-4 opens with ease. Just flip the latches on the window sides and slide it up. A gas-assist mechanism makes this action almost effortless.

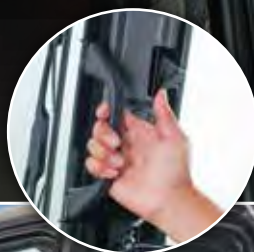

Wider Entrance

The KX033-4 features a much wider door and more ample foot space, making it a breeze to get on and off the excavator.





A. Deluxe Suspension Seat

Kubota's high back suspension seat has been designed for maximum operator comfort and to minimize fatigue during extended machine operation. The deluxe reclining seat offers weight compensation, firm adjustable wrist support and retractable seat belts.

A

B. 2-speed Travel Switch

By placing the 2-speed travel switch on the dozer lever, dozing operations can be done faster and easier.

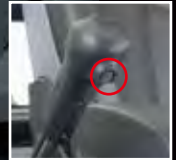

D

C. Cup Holder

With the convenience of a bigger cup holder, you can quench your thirst and work longer without leaving the cab. Or store your cell phone*. The charging port is located conveniently close by.
**Cell phones should not be used during machine operation.*

D. Wrist Rest

A thoughtfully designed wrist rest enhances operation and reduces operator fatigue.

E. Air Conditioning

Enhanced air circulation in the cab results from a more powerful cooling/heating unit and six vents positioned around the operator to offer optimal all weather comfort.



TPSS

Operators can select the ISO pattern or SAE backhoe pattern by turning a switch positioned within easy reach while seated.



SUPERIOR PERFORMANCE

Superior power and outstanding versatility give you the confidence to handle even the most challenging excavating jobs. Precise oil flow makes auxiliary attachments easier to operate. A powerful breakout force enhances productivity. And an array of enhanced functions ensures smooth operation.

Kubota Original Direct Injection Engine

The KX033-4 is powered by Kubota's impressive direct injection engine. Engineered with the power to maximize digging and lifting performance, it also delivers minimized noise, vibration and fuel consumption, and is as well a non-DOC/DPF Tier 4 Final certified engine.



Proportional Flow Control of Auxiliary Circuit (AUX1) and Maximum Oil Flow Setting

Now you can conveniently program up to five different oil flow rates for specific attachments on the new digital control panel. No tools or manual adjustment is required. And, with a maximum AUX 1 circuit oil flow now up to 60 liters per minute you can operate a larger variety of auxiliary attachments than ever before.

Third-line Hydraulic Return

A standard third-line hydraulic return system allows oil return directly to the tank without running through the control valves during operation of one-way hydraulic attachments. This decreases the likelihood of oil contamination, and results in less back pressure and greater oil flow efficiency.

Auto-shift

The KX033-4 auto-shift automatically shifts travel speed from high to low, depending on traction and terrain, allowing smoother operation when dozing and turning.





Auto Idling System

When KX033-4 control levers are in neutral for more than 4 seconds, engine RPM automatically idles. Move any control lever, and engine RPM immediately returns. This innovative feature not only lowers noise and exhaust emissions, but also reduces operating cost and fuel consumption. It can be turned on and off.

Swivel Negative Brake

The swivel negative brake automatically locks the swivel function in its current position. This prevents unexpected machine movement. It's particularly useful during work on slopes or when towing the excavator between worksites.

Large-capacity Variable Displacement Pump

The KX033-4's performance matched boom, arm and bucket movements are the best in the industry. Kubota's unique hydraulic system and large-capacity variable displacement pumps give you the precise control needed to operate smoothly and efficiently in confined quarters. With the hydraulic power harnessed in the KX033-4's front working group, superior digging force is available when you need it.

Front Bush Pins

Bushings on all pivot points on the front attachment and connecting points on the swing bracket is one more feature that adds to the enviable durability of this machine.

Travel Negative Brake

The travel negative brake locks the tracks to prevent inadvertent movement of the machine. This keeps the excavator secure during transport or while parked on slopes.

Easy Maintenance

Kubota's attention to user-friendliness can even be found in KX033-4's engine layout. Primary engine components are consolidated onto one side for easier access so inspections and repairs can be made quickly and easily.



A. Dual Element Air Cleaner

B. Water Separator

C. Fuel Filter

D. Starter Motor

E. Alternator

MAINTENANCE

Fully opening rear and right side hoods and easily accessible engine, control valves, and other components simplify maintenance and repair tasks to help keep your KX033-4 in peak operating condition.

Steel Panels

Durable steel side panels open easily for quick inspection and routine maintenance. Positioning inside the counterweight's edge gives panels added protection against inadvertent damage.

Accumulator

The accumulator helps to change hydraulically driven attachments by clearing residual pressure in the hydraulic lines. It also helps to lower front attachments to the ground if the engine is turned off. Both can be done without restarting the engine. Please see the operator's manual for more information.





DIGITAL PANEL



Standard Mode

- A. Hour Meter**
- B. Coolant Temperature**
- C. Clock**
- D. Fuel Level**
- E. Engine RPM**

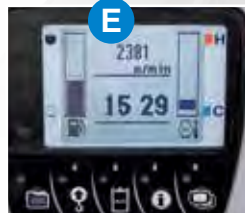

With easy access, simple settings, and easy-to-read indicators and alerts, you'll always be aware of the status of your excavator's critical functions. The wider, more visible display screen with easy push button operation puts convenience at the operator's fingertips. Part of Kubota's Intelligent Control System, the digital panel provides a wealth of user-friendly information to help keep the KX033-4 working safely and efficiently.



Operation History Record

Operation history is automatically recorded on the KX033-4. You can trace back up to 90 days of the machine's usage dates by simply checking the built-in calendar.



Service Mode



Warning Mode



Operation History Record



Max. Oil Flow Setting

Convenient Pre-installed Attachment Icons



AUX (Standard)



Tilt Bucket



Breaker



Clamshell



Auger



Grapple



Rotary Grapple



Brush Cutter

KX033-4 OPTIONS

STANDARD EQUIPMENT

Safety system

- Engine start safety system
- Travel motor with disc brake
- Swivel motor with disc brake
- All hydraulic control
- Travel alarm

Working equipment

- Auxiliary hydraulic circuit 1 with proportional control on right control lever
- 2 working lights on cab and 1 light on the boom
- Dozer blade with float function
- Thumb bracket and relief valve

Operator's Space

- ROPS/OPG (TOP Guard, Level I) canopy
- Weight-adjustable full suspension seat
- Retractable seat belt
- Hydraulic pilot control levers with wrist rests
- Travel levers with foot pedals
- Two pattern selection system
- Digital panel with diagnosis function
- 12V power source
- Cup holder
- Horn

Engine/Fuel system

- Double element air filter
- Auto idling system
- Water separator with drain cock

Undercarriage

- 11.8" (300mm) rubber track
- 1 × upper track roller
- 5 double-flange track rollers on each side
- 2-speed travel switch on dozer lever
- 2-speed travel with auto-shift

Hydraulic system

- Pressure accumulator
- Hydraulic pressure checking ports
- Straight travel circuit
- Third line hydraulic return
- 2 variable pumps and 1 gear pump
- Adjustable maximum oil flow on auxiliary hydraulic circuits 1
- Auxiliary switch (AUX1) on right control lever

Others

- Tool box
- Grease gun holder

OPTIONAL EQUIPMENT

- Cab with A/C

WORKING RANGE

Model		KX033-4		
A	Max. digging height	mm	4980	
B	Max. dumping height	mm	3530	
C	Max. digging depth	mm	3210	
D	Max. vertical digging depth	mm	2235	
E	Max. digging radius at ground	mm	5120	
F	Max. digging radius	mm	5230	
G	Min. turning radius	W/o swing	mm	2020
		W swing	mm	1510
H	Min. tail turning radius	mm	1250	

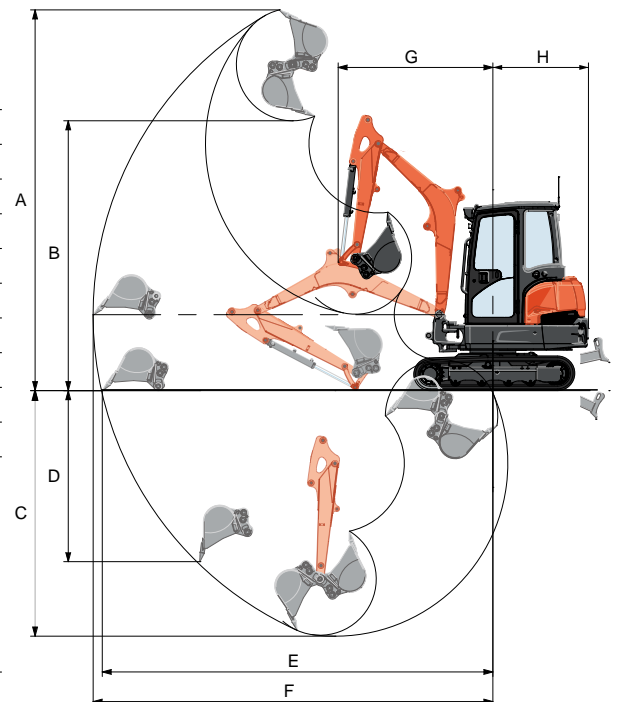

LIFTING CAPACITY

Canopy rubber

LIFT POINT HEIGHT (m)	LIFTING CAPACITY OVER-FRONT BLADE DOWN unit = kg			LIFTING CAPACITY OVER-SIDE unit = kg			
	LIFT POINT RADIUS (m)			LIFT POINT RADIUS (m)			
	3.0	4.0	MAX	3.0	4.0	MAX	
2.5	510	536	549	510	428	398	
1.5	699	585	567	638	418	355	
0.5	909	658	594	606	407	350	
GL	0	973	679	609	596	403	360

Machine with ROPS canopy and rubber crawler, without bucket

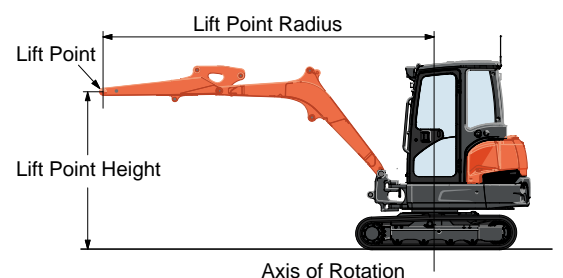

SPECIFICATIONS

Model		KX033-4		
Type of ROPS / OPG (TOP Guard, Level I)		Canopy / Cab		
Type of tracks		Rubber / Steel		
Engine	Model		Kubota D1703M-DI-E4	
	Output (SAE J1995 gross)	HP (kW) / rpm	24.8 (18.5) / 2200	
	Output (SAE J1349 net)	HP (kW) / rpm	23.2 (17.3) / 2200	
	Displacement	cc	1647	
Dimensions	Overall length		mm	4730
	Overall height		mm	2480 / 2470
	Overall width		mm	1550
	Min. ground clearance		mm	290
	Boom offset	Right / Left	mm	410 / 450
	Blade lift	Upper / Low	mm	365 / 375
Hydraulic system	Pump capacity		ℓ/min	39.6 × 2 / 20.9 × 1
	Auxiliary hydraulic flow		ℓ/min	60
	Max. breakout force	Bucket / Arm	kgf	3694 / 1756
Drive system	Travel speed	Low / High	km/h	3.0 / 4.6
	Max. traction force	Low speed	kgf	2763
	Tumbler distance		mm	1665
	Crawler length		mm	2100
	Shoe width	Rubber / Steel	mm	300
	Ground contact pressure	Canopy Rubber / Steel	kgf/cm ²	0.307 / 0.315
		Cab Rubber / Steel	kgf/cm ²	0.321 / 0.329
Swing system	Unit swing speed		rpm	8.9
	Boom swing angle	Left / Right	degree	70 / 48
Blade	Dimensions	Width	mm	1550
		Height	mm	345
	Max. lift above ground		mm	365
	Max. drop below ground		mm	375
	Angle	Left / Right	degree	-
Hydraulic oil (Reservoir / System)		ℓ	44.6 / 61	
Fuel reservoir		ℓ	46.9	
Operating weight (Including operator's weight @ 75 kg)	Canopy Rubber / Steel	kgf	3365 / 3454	
	Cab Rubber / Steel	kgf	3511 / 3600	

The company reserves the right to change the above specifications without notice. This brochure is for descriptive purposes only. Please contact your local Kubota dealer for warranty information. For your safety, Kubota strongly recommends the use of a Rollover Protective Structure (ROPS) and seat belt for almost all applications.

DIMENSIONS

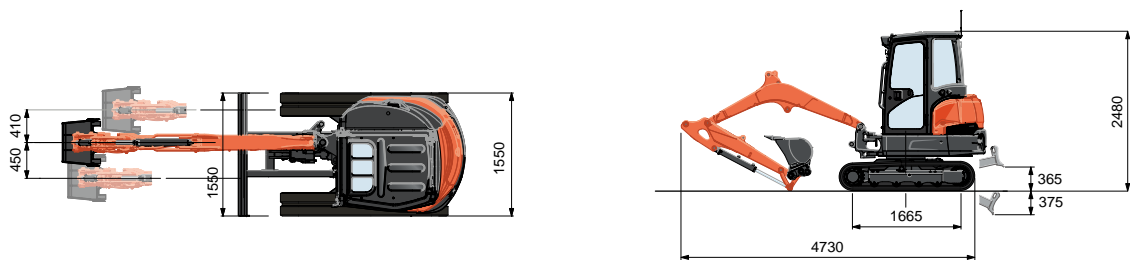

Unit: mm

©2017 Kubota Corporation



KUBOTA Tractor Australia Pty Ltd

25-29 Permas Way, TRUGANINA Vic, 3029
 Freecall: 1800-334-653
 Email: sales@kubota.com.au

Web Site: <http://www.kubota.com.au>

CB Norwood Distributors Ltd

PO Box 1265, 888 Tremain Avenue,
 Palmerston North 0800 KUBOTA
 Tel: 06 356 4920 Fax: 06 356 4939

Web Site: <http://www.kubota.co.nz>